

JUNCTION MANIFOLD - 90°
Side Connections at 90°
(2 per Station)

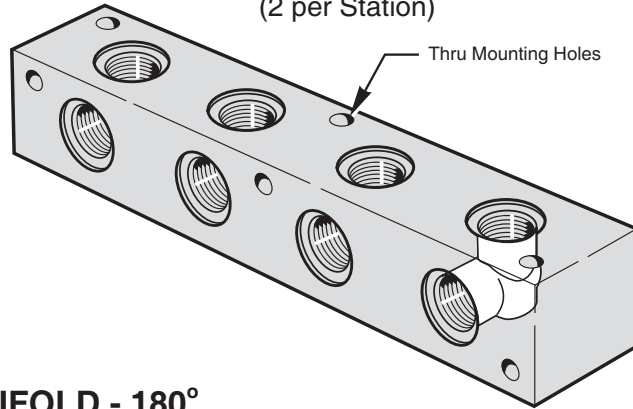

JUNCTION MANIFOLD - 180°
Side Connection Thru
(2 per Station)

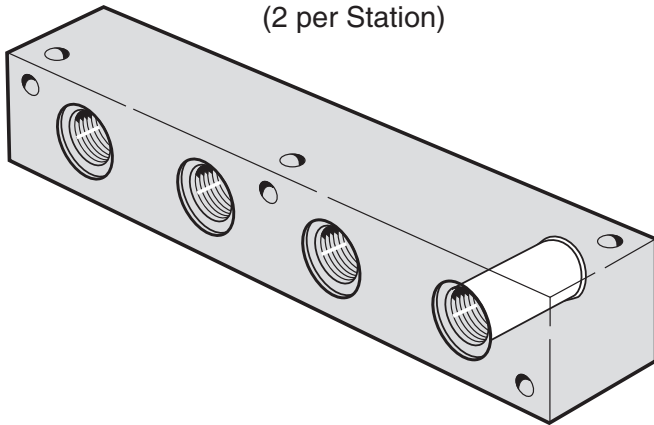

JUNCTION MANIFOLD - 270°
3 Side Connections
Terminating at Manifold's Center
(3 per Station)

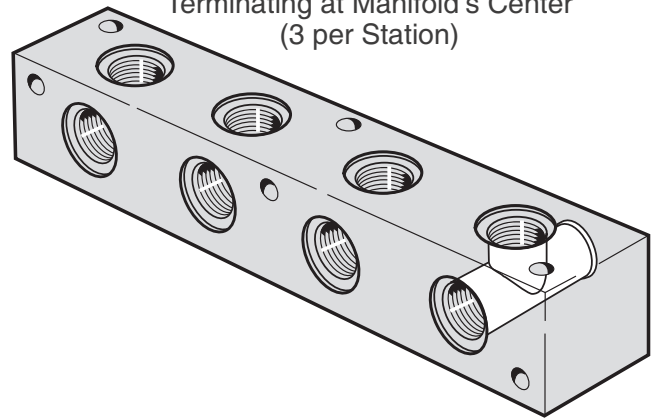

3

MAGNALOY JUNCTION MANIFOLD - PART NUMBER BREAKDOWN

J A - 2 7 0 0 0 / 0 8 S - 0 4 - 1 / Z

Product Code
J - Junction Manifold

Material Code
A - Aluminum
S - Ductile/Steel

Port Angles
09 - 90°
18 - 180°
27 - 270°

End Ports
'000' for all
Junction Manifold

* See size charts for standard sizes and porting. See Page 97 for Mounting Hardware.

01P - 1/16 NPT	04S - #4 SAE
02P - 1/8 NPT	06S - #6 SAE
04P - 1/4 NPT	08S - #8 SAE
06P - 3/8 NPT	12S - #12 SAE
08P - 1/2 NPT	16S - #16 SAE
12P - 3/4 NPT	20S - #20 SAE
16P - 1" NPT	24S - #24 SAE
20P - 1 1/4 NPT	32S - #32 SAE
24P - 1 1/2 NPT	
32P - 2" NPT	

Options
Z - No Options

Design Series

Number of Stations

Side Ports *

##S - SAE
##P - NPTF

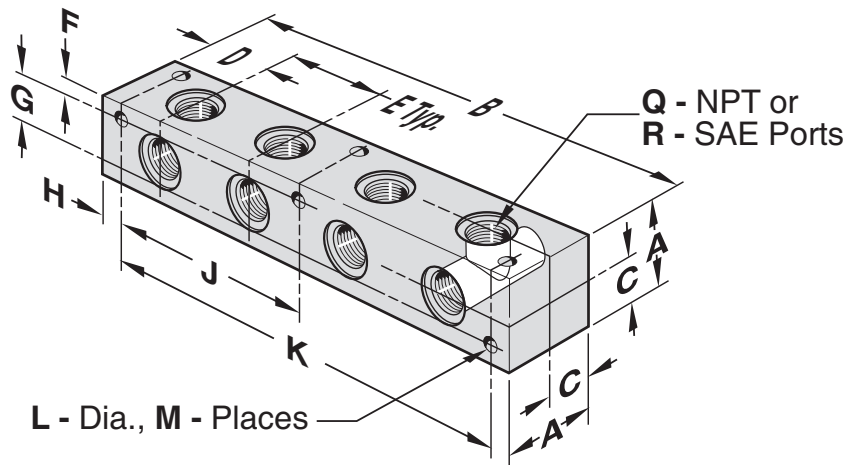

01P SIDE PORT

PART NO.	A	B	C	D	E	F	G	H	J	K	L	M	Q	R
J - _000/01P-02-1/Z	1.500	3.250	0.750	1.000	1.250	0.250	1.000	0.313	--	2.625	0.281	4	1/16	--
J - _000/01P-03-1/Z		4.500							--	3.875		4		
J - _000/01P-04-1/Z		5.750							--	5.125		4		
J - _000/01P-05-1/Z		7.000							--	6.375		4		
J - _000/01P-06-1/Z		8.250							3.813	7.625		6		
J - _000/01P-07-1/Z		9.500							3.813	8.875		6		
J - _000/01P-08-1/Z		10.750							5.063	10.125		6		
J - _000/01P-09-1/Z		12.000							5.063	11.375		6		
J - _000/01P-10-1/Z		13.250							6.313	12.625		6		

02P SIDE PORT

PART NO.	A	B	C	D	E	F	G	H	J	K	L	M	Q	R
J - _000/02P-02-1/Z	1.500	3.625	0.750	1.125	1.375	0.250	1.000	0.313	--	3.000	0.281	4	1/8	--
J - _000/02P-03-1/Z		5.000							--	4.375		4		
J - _000/02P-04-1/Z		6.375							--	5.750		4		
J - _000/02P-05-1/Z		7.750							--	7.125		4		
J - _000/02P-06-1/Z		9.125							4.250	8.500		6		
J - _000/02P-07-1/Z		10.500							4.250	9.875		6		
J - _000/02P-08-1/Z		11.875							5.625	11.250		6		
J - _000/02P-09-1/Z		13.250							5.625	12.625		6		
J - _000/02P-10-1/Z		14.625							7.000	14.000		6		

04 SIDE PORT

PART NO.	A	B	C	D	E	F	G	H	J	K	L	M	Q	R
J - _000/04_-02-1/Z	1.750	3.875	0.875	1.063	1.750	0.250	1.250	0.313	--	3.250	0.281	4	1/4	-4
J - _000/04_-03-1/Z		5.625							--	5.000		4		
J - _000/04_-04-1/Z		7.375							--	6.750		4		
J - _000/04_-05-1/Z		9.125							--	8.500		4		
J - _000/04_-06-1/Z		10.875							5.125	10.250		6		
J - _000/04_-07-1/Z		12.625							5.125	12.000		6		
J - _000/04_-08-1/Z		14.375							6.875	13.750		6		
J - _000/04_-09-1/Z		16.125							6.875	15.500		6		
J - _000/04_-10-1/Z		17.875							8.625	17.250		6		

06_ SIDE PORT

PART NO.	A	B	C	D	E	F	G	H	J	K	L	M	Q	R
J - _000/06_-02-1/Z	1.750	5.000	0.875	1.500	2.000	0.250	1.250	0.313	--	4.375	0.281	4	3/8	-6
J - _000/06_-03-1/Z		7.000							--	6.375		4		
J - _000/06_-04-1/Z		9.000							--	8.375		4		
J - _000/06_-05-1/Z		11.000							--	10.375		4		
J - _000/06_-06-1/Z		13.000							6.188	12.375		6		
J - _000/06_-07-1/Z		15.000							6.188	14.375		6		
J - _000/06_-08-1/Z		17.000							8.188	16.375		6		
J - _000/06_-09-1/Z		19.000							8.188	18.375		6		
J - _000/06_-10-1/Z		21.000							10.188	20.375		6		

08_ SIDE PORT

PART NO.	A	B	C	D	E	F	G	H	J	K	L	M	Q	R
J - _000/08_-02-1/Z	2.000	5.375	1.000	1.500	2.375	0.250	1.500	0.313	--	4.750	0.281	4	1/2	-8
J - _000/08_-03-1/Z		7.750							--	7.125		4		
J - _000/08_-04-1/Z		10.125							--	9.500		4		
J - _000/08_-05-1/Z		12.500							--	11.875		4		
J - _000/08_-06-1/Z		14.875							7.125	14.250		6		
J - _000/08_-07-1/Z		17.250							7.125	16.625		6		
J - _000/08_-08-1/Z		19.625							9.500	19.000		6		
J - _000/08_-09-1/Z		22.000							9.500	21.375		6		

12_ SIDE PORT

PART NO.	A	B	C	D	E	F	G	H	J	K	L	M	Q	R
J - _000/12_-02-1/Z	2.500	6.875	1.250	1.813	3.250	0.280	1.940	0.375	--	6.125	0.344	4	3/4	-12
J - _000/12_-03-1/Z		10.125							--	9.375		4		
J - _000/12_-04-1/Z		13.375							--	12.625		4		
J - _000/12_-05-1/Z		16.625							--	15.875		4		
J - _000/12_-06-1/Z		19.875							9.563	19.125		6		
J - _000/12_-07-1/Z		23.125							9.563	22.375		6		

16_ SIDE PORT

PART NO.	A	B	C	D	E	F	G	H	J	K	L	M	Q	R
J - _000/16_-02-1/Z	3.000	7.750	1.500	2.000	3.750	0.344	2.312	0.375	--	7.000	0.406	4	1	-16
J - _000/16_-03-1/Z		11.500							--	10.750		4		
J - _000/16_-04-1/Z		15.250							--	14.500		4		
J - _000/16_-05-1/Z		19.000							7.250	18.250		6		
J - _000/16_-06-1/Z		22.750							11.000	22.000		6		

20_ SIDE PORT

PART NO.	A	B	C	D	E	F	G	H	J	K	L	M	Q	R
J - _000/20_-02-1/Z	3.500	8.500	1.750	2.250	4.000	0.410	2.688	0.500	--	7.500	0.531	4	1-1/4	-20
J - _000/20_-03-1/Z		12.500							--	11.500		4		
J - _000/20_-04-1/Z		16.500							--	15.500		4		
J - _000/20_-05-1/Z		20.500							7.750	19.500		6		

24_ SIDE PORT

PART NO.	A	B	C	D	E	F	G	H	J	K	L	M	Q	R
J - _000/24_-02-1/Z	4.000	10.000	2.000	2.500	5.000	0.410	3.188	0.500	--	9.000	0.531	4	1-1/2	-24
J - _000/24_-03-1/Z		15.000							--	14.000		4		
J - _000/24_-04-1/Z		20.000							9.500	19.000		6		